

This document is the property of Amphenol Corporation and is delivered on the express condition that it is not to be disclosed, reproduced or used, in whole or in part, for manufacture or sale by anyone other than Amphenol Corporation without its prior consent, & that no right is granted to disclose or to use any information in this document.

REVISIONS				
SYM	ECN	DESCRIPTION	DATE	APPROVED
A	HK2087	Preliminary Release	11/01/01	Hu
B	HK2115	Per ECN	04/17/02	lp
C	HK2338	C3: Move the logo "Amphenol" from center to the left and add the logo "EA"	09/20/02	lp

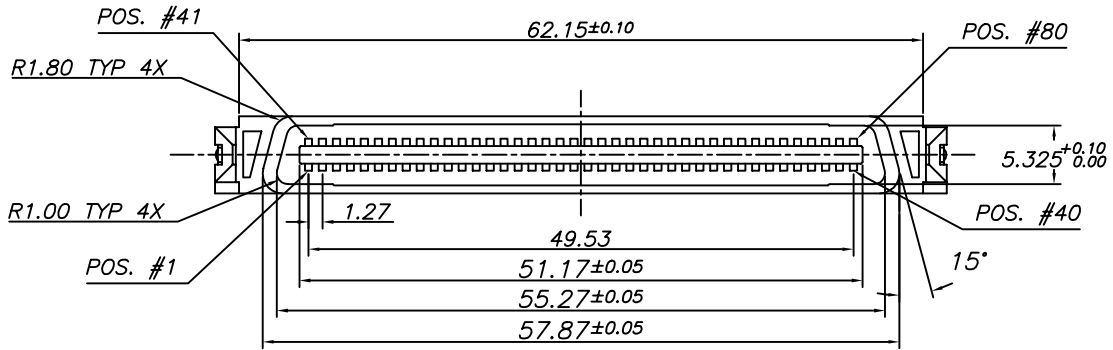

NOTES

- MAT'L
PIN : COPPER ALLOY
HSG : LIQUID CRYSTAL POLYMER UL94V-0
COLOR: BLACK
BOARDLOCK : COPPER ALLOY
- PLATING
CONTACT: Au 0.2um MIN
SOLDER TAIL: TIN-LEAD 1.27 um MIN
BOARDLOCK: Ni 1.27um MIN
- ORDER P/N: SCA-8001-001-1

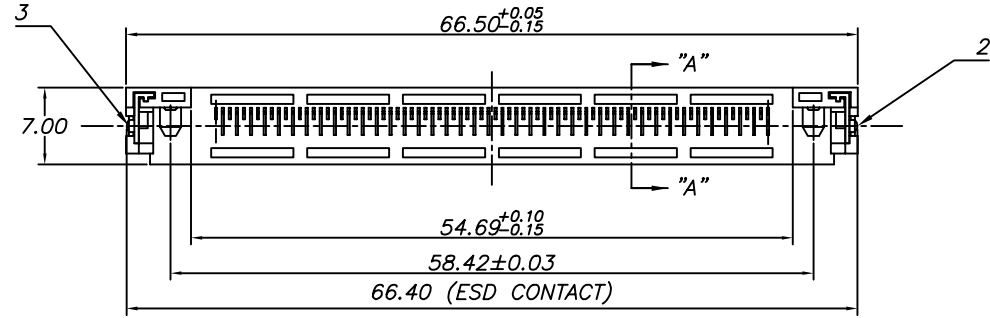
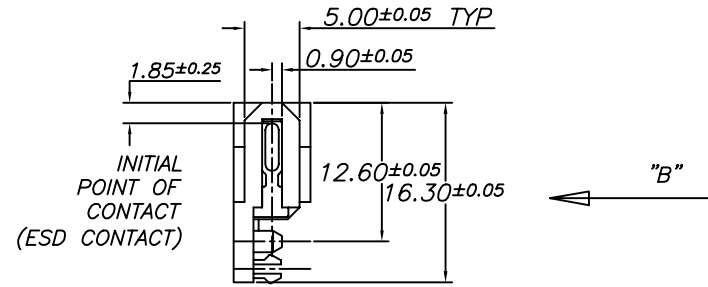
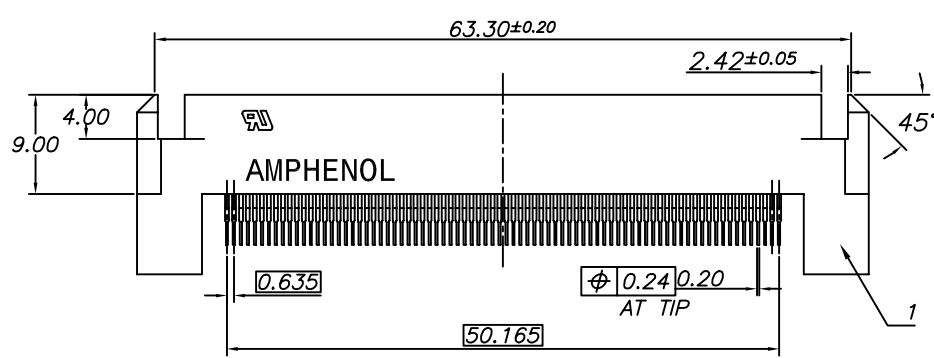

ITEM NO	PART OR IDENTIFICATION NO	NOMENCLATURE OR DESCRIPTION	QTY REQ'D
5	----	Signal Pin, Phosphor Bronze, 0.20mm thickness, 0.20um gold plated selective	40
4	----	Signal Pin, Phosphor Bronze, 0.20mm thickness, 0.20um gold plated selective	40
3	----	Boardlock, Phosphor Bronze, 0.25mm thickness, Ni plated	1
2	----	Boardlock, Phosphor Bronze, 0.25mm thickness, Ni plated	1
1	----	Housing, Plug, LCP UL94V-0	1

UNLESS OTHERWISE SPECIFIED TOLERANCES		APPROVAL		DATE	Amphenol Amphenol East Asia Limited
U.S.	METRIC	DRAWN	Joseph.zhou	09/20/02	
.X +/-	0.20	CHECKED	lp	09/20/02	TITLE SCA2 PLUG CONNECTOR (SHORT PEG)
.XX +/-	0.10	CHECKED			
.XXX +/-	0.05	DRAWING FILE : DRAWING\SCA\CSCA80010011.dwg			SIZE A3
FRACTIONS +/-	1"	REMOVE SHARP EDGES			DRAWING NO. SCA-8001-001-1
ANGLES +/-		ANGLE OF PROJECTION			REV. C
DIMENSIONS					SCALE NONE
U.S.	INCHES				SHEET 1 OF 2
(METRIC)	(MM)				

CUSTOMER DRAWING

This document is the property of Amphenol Corporation and is delivered on the express condition that it is not to be disclosed, reproduced or used, in whole or in part, for manufacture or sale by anyone other than Amphenol Corporation without its prior consent, & that no right is granted to disclose or to use any information in this document.

REVISIONS				
SYM	ECN	DESCRIPTION	DATE	APPROVED
		SEE SHEET 1		

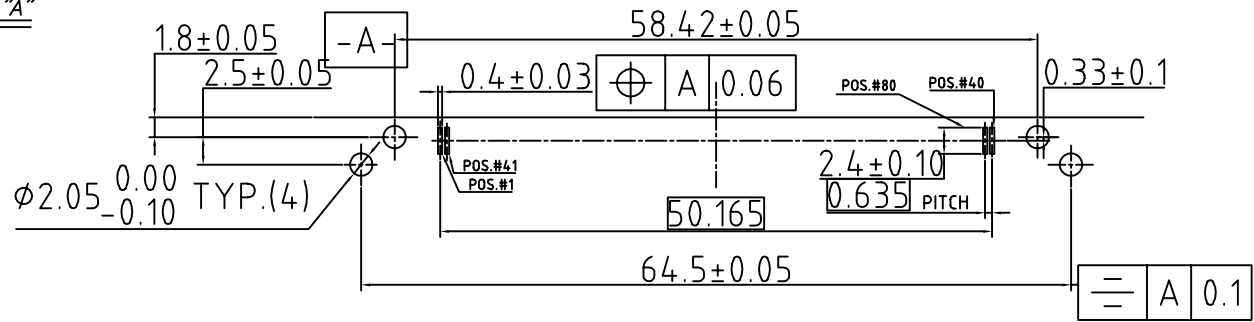
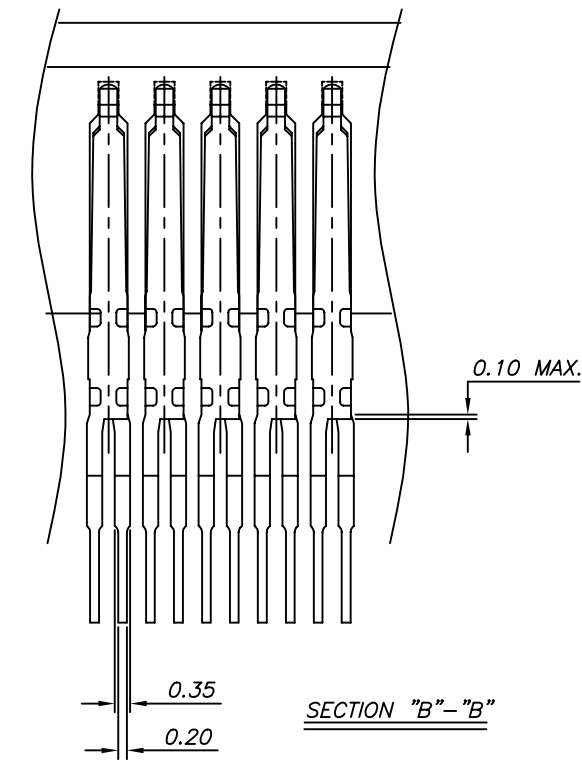
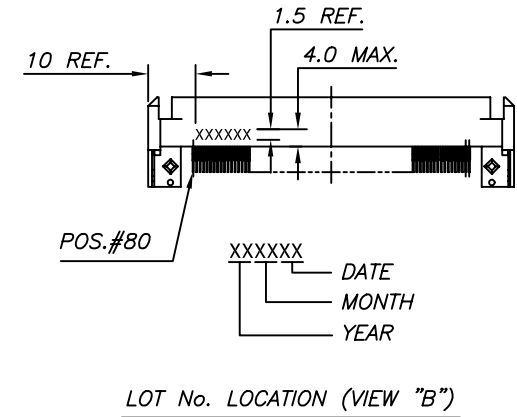
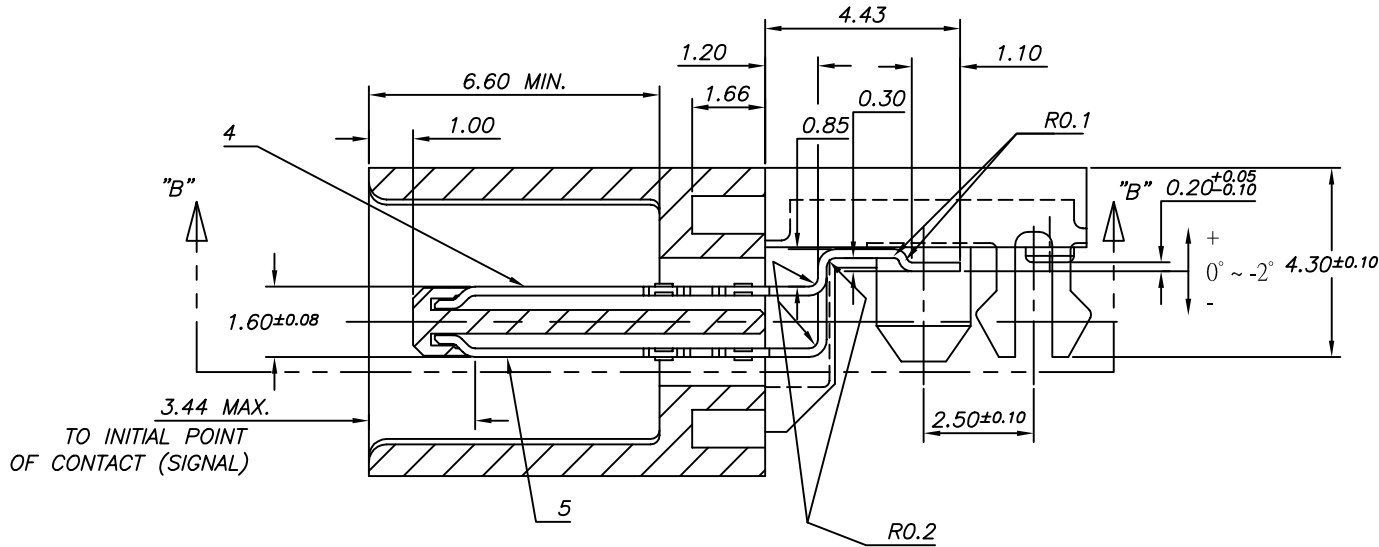

CUSTOMER DRAWING

ITEM NO	PART OR IDENTIFICATION NO	NOMENCLATURE OR DESCRIPTION	QTY REQ'D
PARTS LIST			
UNLESS OTHERWISE SPECIFIED TOLERANCES		APPROVAL	DATE
U.S.		DRAWN Joseph.zhou	09/20/02
METRIC		CHECKED lp	09/20/02
.X +/- 0.20		CHECKED	
.XX +/- 0.10		DRAWING FILE :	
.XXX +/- 0.05		TITLE	
FRACTIONS +/- 1"		SCA-2 PLUG CONNECTOR (SHORT PEG)	
ANGLES +/-		SIZE DRAWING NO.	
FOR MATERIALS AND FINISHES SEE NOTES		A3 C SCA-8001-001-1 C	
REMOVE SHARP EDGES		SCALE NONE	
ANGLE OF PROJECTION		SHEET 2 OF 2	
DIMENSIONS		REV.	
U.S. INCHES		C	
(METRIC) (MM)			