

SMPS SERIES

SMPS Interface at a Glance

SV Microwave offers a complete line of SMPS connectors. The SMPS connector utilizes the same great features of the SMP and SMPM connector series in an even smaller package. The SMPS series is ideal in applications where density is of the utmost importance.

Electrical Specifications

Impedance	50Ω
Frequency	100 GHz
VSWR	1.10:1 to 26.5 GHz typ.; 1.25:1 to 65 GHz typ.
Insertion Loss	.07 √ f
Shielding Effectiveness	≥ -80 dB typ.
Dielectric Withstanding Voltage	250 VRMS

Mechanical Specifications

	SB	FD
Mating Cycles	500	100
Force to Engage/Disengage	1.2 / 1.0 lbs	2.5 / 4.5 lbs
Axial Misalignment		.010"
Radial Misalignment		± .010"

Environmental Specifications

Temperature Rating	-65°C to +165°C
Corrosion (Salt Spray)	MIL-STD-202, Method 101, Condition B
Vibration	MIL-STD-202, Method 204, Condition D, 20 Gs
Shock	MIL-STD-202, Method 213, Condition I, 100 Gs
Thermal Shock	MIL-STD-202, Method 107. Cond. B, -65°C to +165°C
Barometric Pressure (Altitude)	MIL-STD-202, Method 105, Condition C, 70k Ft.

Note: Specifications, dimensions and images are typical for the series and may vary by part number

Male Cable Connector

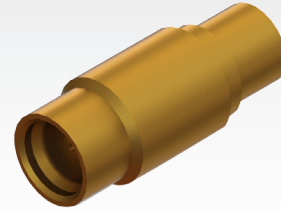
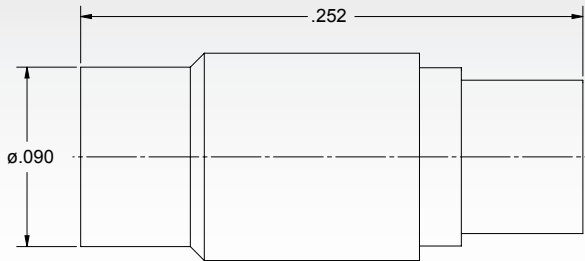

Detent	Cable	P/N
SB	.047	3811-40002
FD	.047	3811-40001

Female Cable Connector

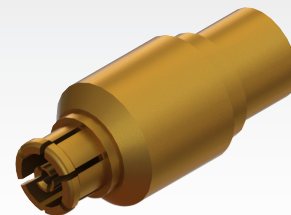
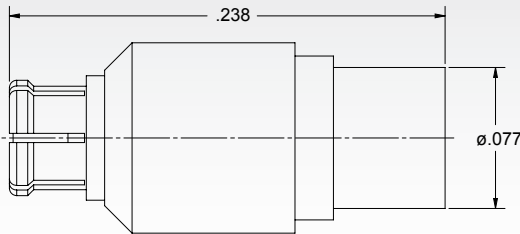

Cable	P/N
.047	3821-40001

Female Cable Connector, Swept R/A

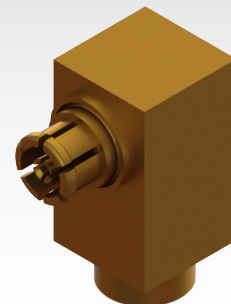
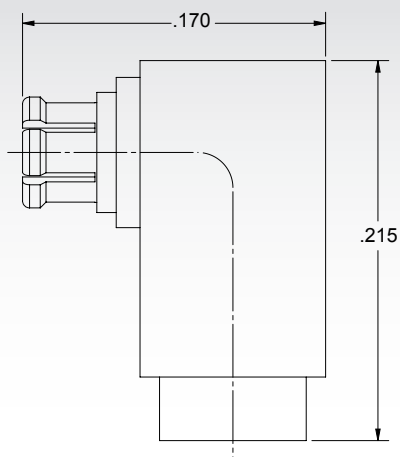

Cable	P/N
.047	3822-40001

SMPS SERIES

Male Solder-In Connector (.009")

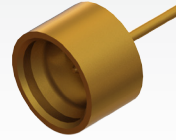
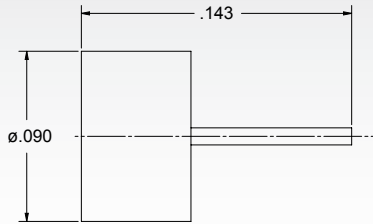

Detent	P/N
SB	3811-40005
FD	3811-40006

Male Surface Mount Connector

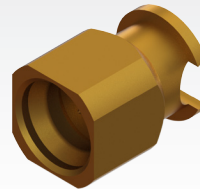
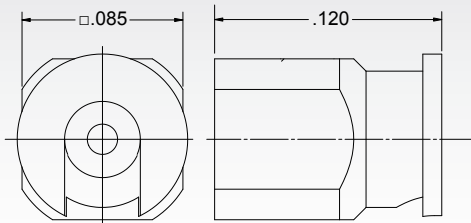

Detent	P/N
SB	3811-40023
FD	3811-40022

Contact SV directly to access our database of recommended PCB layouts

Male Surface Mount Hermetic Connector (.009")

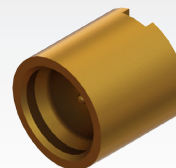
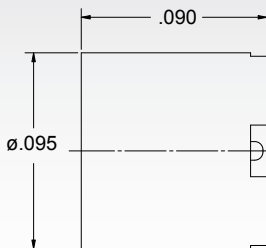

Detent	P/N
SB	3811-60005
FD	3811-60006

Contact SV directly to access our database of recommended PCB layouts

Socket D38999 Cable Contact (Size 16)

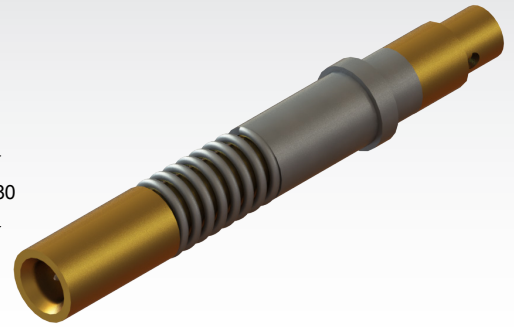
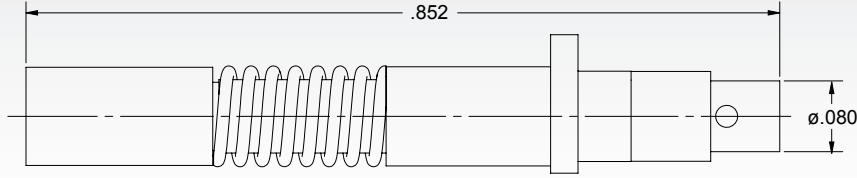

Cable	P/N
.047	SF9911-60001

Pin D38999 Cable Contact (Size 16)

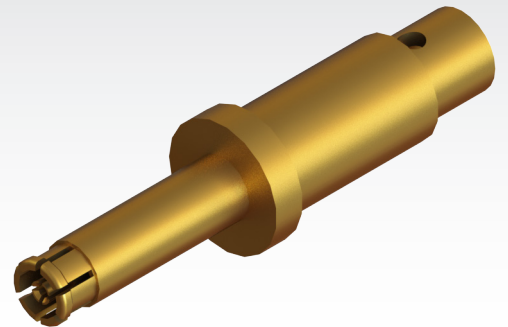
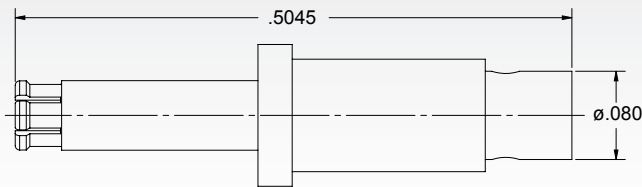

Cable	P/N
.047	9921-40001

Male Edge Launch Connector

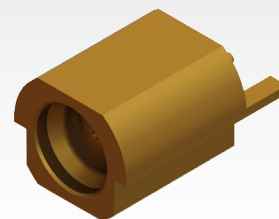
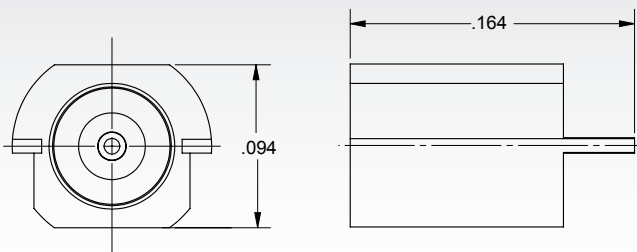

Detent	P/N
SB	3811-40004
FD	3811-40003

Contact SV directly to access our database of recommended PCB layouts

SMPS SERIES

Female to Female Bullet

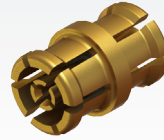
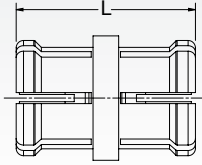

P/N	L
1138-4001	.098"
1138-4002	.118"
1138-4003	.134"
1138-4004	.188"

SMPS Male to 2.4mm Male Adapter

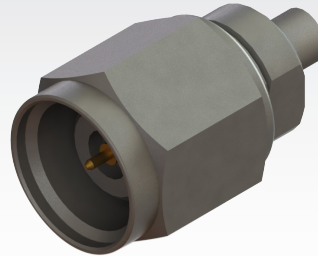
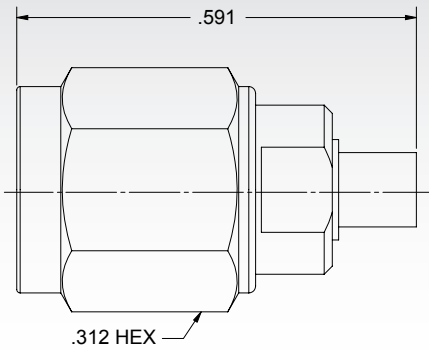

Detent	P/N
SB	SF1116-6023
FD	SF1116-6024

SMPS Female to 2.4mm Male Adapter

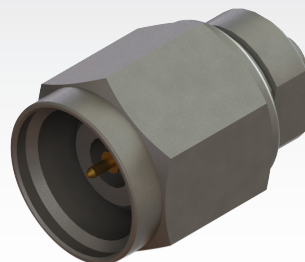
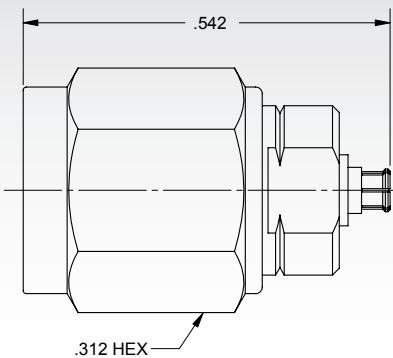

P/N
SF1116-6025

Female Termination

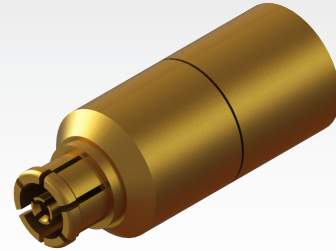
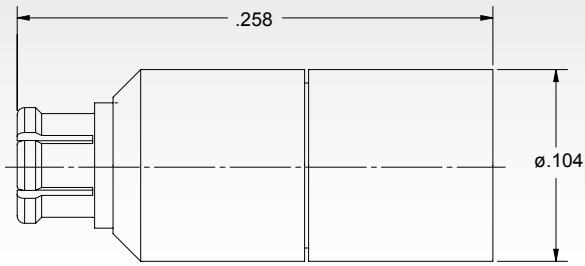

P/N
8038-4001

Male Termination

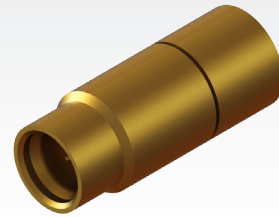
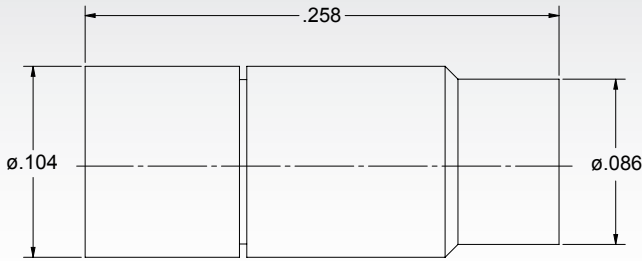

Detent	P/N
SB	8038-6003
FD	8038-6004

Male Short

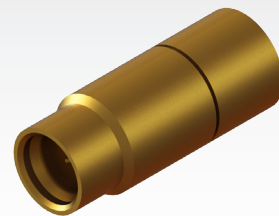
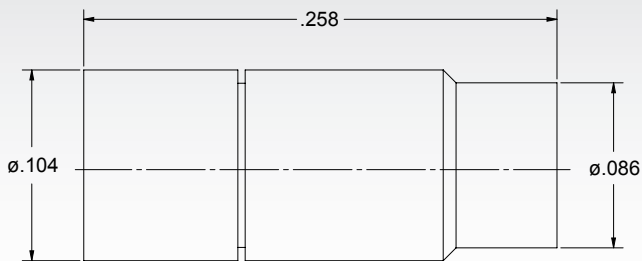

Detent	P/N
SB	8038-6005
FD	8038-6006

SMPS SERIES

SMPS SERIES

Female Cable Removal Tool

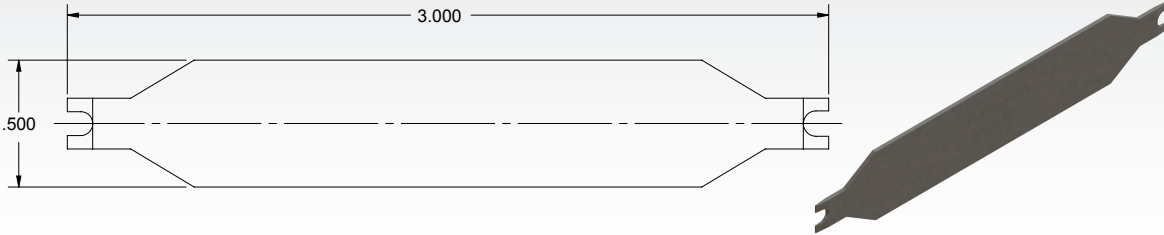

P/N

500-38-002

Female Removal Tool

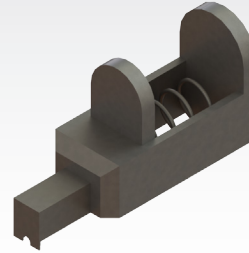
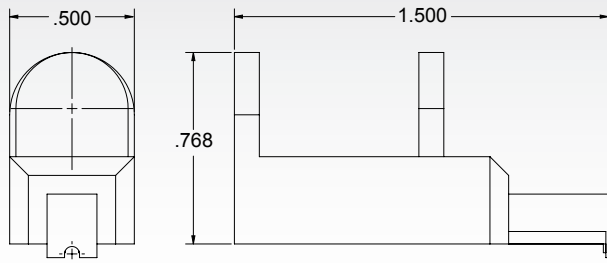

P/N

500-38-003

Female Bullet Removal Tool

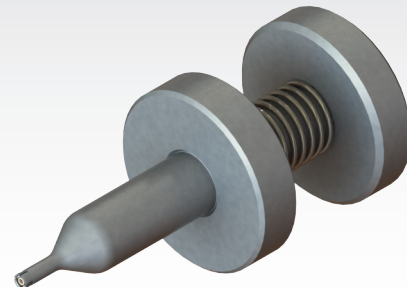
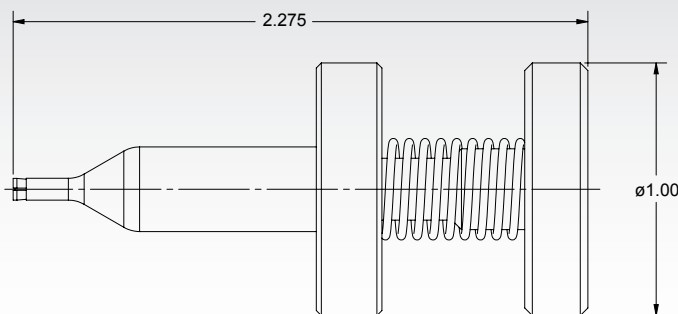

P/N

500-38-004